

# Northumbria Research Link

Citation: Tang, Xuan, Ghassemlooy, Zabih, Rajbhandari, Sujan, Popoola, Wasiu Oyewole and Lee, Chung Ghiu (2011) Coherent optical binary polarisation shift keying heterodyne system in the free-space optical turbulence channel. IET Microwaves, Antennas & Propagation, 5 (9). pp. 1031-1038. ISSN 1751-8725

Published by: IET

URL: <http://dx.doi.org/10.1049/iet-map.2010.0221> <<http://dx.doi.org/10.1049/iet-map.2010.0221>>

This version was downloaded from Northumbria Research Link:  
<http://nrl.northumbria.ac.uk/3722/>

Northumbria University has developed Northumbria Research Link (NRL) to enable users to access the University's research output. Copyright © and moral rights for items on NRL are retained by the individual author(s) and/or other copyright owners. Single copies of full items can be reproduced, displayed or performed, and given to third parties in any format or medium for personal research or study, educational, or not-for-profit purposes without prior permission or charge, provided the authors, title and full bibliographic details are given, as well as a hyperlink and/or URL to the original metadata page. The content must not be changed in any way. Full items must not be sold commercially in any format or medium without formal permission of the copyright holder. The full policy is available online: <http://nrl.northumbria.ac.uk/policies.html>

This document may differ from the final, published version of the research and has been made available online in accordance with publisher policies. To read and/or cite from the published version of the research, please visit the publisher's website (a subscription may be required.)

[www.northumbria.ac.uk/nrl](http://www.northumbria.ac.uk/nrl)



# COHERENT OPTICAL BINARY POLARIZATION SHIFT KEYING HETERODYNE SYSTEM IN THE FREE SPACE OPTICAL TURBULENCE CHANNEL

X. Tang<sup>1</sup>, Z. Ghassemlooy<sup>1</sup>, S. Rajbhandari<sup>1</sup>, W. O. Popoola<sup>2</sup> and C. G. Lee<sup>3</sup>

1: Optical Communication Research Group, School of CEIS, Northumbria University, UK

2: Institute for Digital Communications, School of Engineering, University of Edinburgh, Edinburgh, UK

3: Department of Electronic Engineering, Chosun University, S. Korea

e-mail: xuan.tang@unn.ac.uk; z.ghassemlooy@unn.ac.uk

## ABSTRACT

In this paper, analytical and simulation results for the bit error rate (BER) performance and fading penalty of a coherent optical binary polarization shift keying (2PolSK) heterodyne system adopted for a free space optical (FSO) communication link modeled as the log-normal and the negative exponential atmospheric turbulence channels are presented. The conditional and unconditional BER expressions are derived, demonstrating the comprehensive similarity between the 2PolSK and the binary frequency shift keying (2FSK) schemes with regards to the system sensitivity. The power penalty due to the non-ideal polarization beam splitter (PBS) is also analyzed. The receiver sensitivity employing 2PolSK is compared with other modulation schemes in the presence of turbulence and the phase noise. The results show that 2PolSK offers improved signal-to-noise ratio (SNR) performance compared to the binary amplitude shift keying (2ASK).

## I. INTRODUCTION

The research in the field of FSO communication has grown exponentially since 1970 and a large number of commercial products based on FSO technology are now readily available. FSO is proposed as a complementary technology to the radio frequency (RF) technology. FSO offers an unregulated bandwidth in excess of THz and very high speed which makes them extremely

attractive means of meeting the ever-increasing demand for broadband traffic, mostly driven by last-mile access network and HDTV broadcasting services [1]. FSO systems based on the wavelength division multiplexing (WDM) technology can reach up to 1 Terabit/s capacity or even beyond [2]. Further advantages include smaller and more compact transceivers, reduced installation and development cost and immunity to the electromagnetic interference [1].

On the other hand, FSO link with an inherent low probability of intercept and anti-jamming characteristics is among the most secure of all wide-area connectivity solutions. Unlike many RF systems that radiate signals in all directions, thus making the signal available to all within the receiving range, the FSO transceivers, uses a highly-directional and cone-shaped laser beam normally installed high above street level with a line-of-sight propagation path. Therefore the interception of a laser beam is extraordinarily difficult and anyone tapping into the systems can easily be detected as the intercept equipment must be placed within the very narrow optical foot print. Even if portion of the beam is intercepted, an anomalous power loss at the receiver could cause an alarm via the management software. To protect the overshoot energy against being intercepted at the receiver part, a window or a wall can be set up directly behind the receiver [1, 3]. Based on these features, FSO communications systems developed for voice, video and broadband data communications are used by security organizations such as government and military [2].

However, the optical carrier (laser beam) propagating through the free space channel suffers from the atmospheric turbulence induced fading. The atmospheric turbulence is caused by the fluctuations of the atmosphere's refractive index due to inhomogeneities in temperature and pressure in atmosphere [4, 5]. This leads to random fluctuations in the direction, intensity and phase of the laser beam carrying the information [6]. Whereas, it has been experimentally verified that polarization is less sensitive to the turbulence fluctuation experienced by the laser beam propagating through the channel [7].

ASK, PSK, differential PSK(DPSK) and FSK are the most common band-pass modulation

formats adopted for optical and non-optical communication systems. ASK with the on-off keying (OOK) format is the simplest and most widely used but it is highly sensitive to the channel turbulence [3]. To achieve the optimal performance, an adaptive thresholding scheme has to be applied at the receiver, thus increasing the system complexity. Compared to the ASK (OOK), FSK, PSK and DPSK techniques require no adaptive thresholding scheme and offer improved performance in the presence of turbulence [3]. However, angular modulation schemes are highly sensitive to the phase noise, thus requiring a complex synchronization at the receiver [8]. Furthermore, the frequency offset in DPSK leads to the additional power penalty owing to delayed and undelayed bits not being in phase [9]. The FSK scheme is bandwidth inefficient and offers inferior BER performance compared to the PSK and DPSK in the additive white Gaussian noise (AWGN) channel [9].

PolSK is proposed as an alternative modulation technique to both envelop- and phase- based modulation schemes. The digital information is encoded in the state of polarization (SOP) of the laser source [10, 11]. Stokes parameters are used to represent the SOP so the symbol constellation is scattered over a three-dimensional (3-D) space [11]. PolSK offers high immunity to the laser phase noise [9, 11]; and maintains SOPs over a long propagation link [5, 7]. In comparison to DPSK and FSK modulation techniques, the PolSK signal doesn't suffer from excess frequency chirp generated by the all-optical processing devices [9]. Additionally, PolSK modulation is especially attractive for the peak power limited systems because of its constant envelope, which also demonstrates reduced sensitivity to the self phase modulation (SPE) and the cross phase modulation (XPM) [11].

The objective of this work is to carry out the analysis of an optical coherent heterodyne system employing 2PolSK scheme in the presence of turbulence. The turbulence channel is modeled as the lognormal and the negative exponential distributions covering weak to strong turbulence regimes. The FSO link under consideration is line-of-sight, thus only the background radiation

modeled as an AWGN is considered. The power penalty caused by the non-ideal polarization beam splitter (PBS) will also be discussed.

The rest of the paper is organized as follows: the lognormal turbulence and the negative exponential turbulence models for the FSO channel are introduced in Section II, followed by the detailed description of the proposed 2PolSK heterodyne transceiver structure in Section III. The conditional and unconditional BER expressions of the 2PolSK system with an ideal PBS are derived in section IV. The analysis of the non-ideal PBS impact on the BER is showed in section V. Section VI presents the simulation results of the BER performance in comparison with other modulation formats in the presence of weak and strong turbulence regimes. The conclusion is given in Section VII.

## II. TURBULENCE MODEL

### A. The lognormal model

In FSO links signal fading is the result of the received signal fluctuation caused by the atmospheric turbulence. The fading strength depends on the link length, the operating wavelength and the channel refractive index structure parameter  $C_n^2$ . The weak atmospheric turbulence regime can be described by the lognormal distribution [12, 13] and it is characterized by the Ryotov variance  $\sigma^2$  :

$$\sigma^2 = 1.23 C_n^2 k^2 L$$

where  $L$  is the propagation distance and  $k$  is the wave number. The limitation of the log-normal model is defined by the Ryotov variance range  $0.1 < \sigma^2 < 10$  [14].

The probability density function (PDF) of the received irradiance in the log-normal channel is given by [14]:

$$\frac{I_{sc}}{I_{ns}} = \frac{1}{1 + \frac{1}{2} \frac{1}{\Gamma} \frac{1}{\Gamma}} \quad (1)$$

where  $I_{sc}$  represents the received irradiance at the receiver and  $I_{ns}$  is the received irradiance without scintillation.

### B. The negative exponential model

For a strong atmospheric turbulence  $\Gamma \gg 1$ , the negative exponential model should be adopted [14]. The intensity fluctuation of the laser field transmitted through the strong turbulence channel is experimentally verified [14] to obey the Rayleigh distribution which implies negative exponential statistics for the irradiance. The expression is given as:

$$P(I) = \frac{1}{I} \exp\left(-\frac{I}{\Gamma}\right) \quad (2)$$

Other turbulence models such as the I-K [15] and the gamma-gamma [16] are all included in the negative exponential distribution in the limit of strong turbulence.

## III. SYSTEM DESCRIPTION

The block diagram of the proposed transmitter is shown in Figure 1. The PolSK modulator is based on the LiNbO<sub>3</sub> device with the operating wavelength of 1550 nm [17].  $V_a$  and  $V_b$  are used to control the amount of light launched in either horizontal polarization and the relative phase of the two polarizations, respectively. The third electrode  $V_{match}$  applied to the 3 dB coupler is used for wavelength matching.  $\hat{x}$  and  $\hat{y}$  are the axes of polarization used to represent the input digital symbols '0' and '1', respectively. Thus the constant optical power has been achieved at the output of the PolSK modulator in order to fully utilize the output power of the laser source. To increase the power launched into the FSO channel one might use an optical amplifier at the output of the PolSK modulator.

Figure 2 represents the block diagram of the proposed coherent optical PolSK heterodyne

receiver. An optical lens is used to focus the received beam into the receiver. The received signal  $E_r(t)$  can be viewed in both cases as two orthogonal ASK signals, related to orthogonal components of the transmitted optical field. The local oscillator  $E_{lo}(t)$  is linearly polarized at with respect to the receiver reference axes. Uncorrelated  $E_r(t)$  and  $E_{lo}(t)$  signals are given by:

$$\begin{aligned} & \text{---} \\ & \text{---} \end{aligned}$$

where  $P_r$  and  $P_{lo}$  are the received signal and local oscillator signal powers, respectively. and are the angular frequencies and phase noises for the received and local oscillator fields, respectively and  $m(t)$  is the binary information.

$E_r(t)$  and  $E_{lo}(t)$  are mixed using an unbalanced directional coupler with a transfer matrix given by [8]:

$$\begin{aligned} & \text{---} \\ & \text{---} \end{aligned}$$

where is the power splitting ratio.

Therefore, the optical field  $E_{dc}(t)$  at the coupler output and consequently at the PBS input is given by:

$$\begin{aligned} & \text{---} \\ & \text{---} \end{aligned}$$

The outputs of the PBS are defined as:

$$\begin{aligned} & \text{---} \\ & \text{---} \end{aligned}$$

Assuming an electron is generated by each detected photon, the outputs of two identical optical

receivers are passed through ideal BPFs (of a one-sideband bandwidth  $W = 2R_b$ , where  $R_b$  is the data rate) with the outputs defined as:

$$\begin{aligned} & \text{-----} \\ & \text{-----} \end{aligned}$$

where  $R$  is the photodiode responsivity,  $\omega_c$  and  $\phi_c$  are the intermediate angular frequency (IF) and the intermediate phase noise, respectively. The system noises  $\{n_x(t), n_y(t)\}$  are modeled as independent, uncorrelated AWGN noises with a zero mean and a variance  $\sigma_n^2 = WN_0$ , where  $N_0$  is the one-sideband noise power spectral density.

The ideal square-law demodulators composed of electrical mixers, low-pass filters, a sampler and a threshold detector is used to recover the information signal. Note that the phase noise contribution is not included because the square-law demodulation has been adopted [8].

Since the optical field is linearly polarized and its power is unchanged, the Stokes parameters are expressed as [18]:

$$\begin{aligned} & \text{-----} \\ & \text{-----} \end{aligned}$$

where  $S_0, S_1, S_2$  and  $S_3$  are the estimation Stokes parameters; and  $\{n_i(t)\}_{i=0,1,2,3}$  are the noise contributions which are independent of the received SOP and have the same variance. Note that the proposed 2PolSK refers only to the parameter  $S_1$ . A digital symbol ‘0’ is assumed to have been received if  $S_1$  is above the threshold level of zero and ‘1’ otherwise. Two orthogonal SOPs map onto opposite points at  $S_1$  on the equator with respect to the origin in the Poincare sphere shown in Figure 3.



The following hypotheses must be presumed in such a way that the quantum limit of the proposed receiver can thus be determined [8]:

- To neglect the penalty induced by the unbalanced directional coupler, its coefficient is chosen to be close to unity;
- The power of the LO power is assumed to be sufficiently high;
- The responsivity of the PD is assumed to be equal to unity;
- Filters don't cause any signal distortion and only limit the noise power and eliminate the undesired signal components;
- PDs and filters on different electronic branches at the receiver are assumed to be identical.

#### IV. BIT ERROR PROBABILITY ANALYSIS

Assuming independent and identically distributed (i.i.d.) data transmission, the total probability of error  $P_{ec}$  conditioned on the received irradiance is given by:

$$P_{ec} = \frac{1}{2} P(e|0) + \frac{1}{2} P(e|1)$$

where  $P(e|0)$  is the conditional bit error probability for receiving a '1' provided a '0' was sent.

Noise signals  $\{n_x(t), n_y(t)\}$ , including the background noise and the quantum noise can be expressed as [19]:

where  $\{n_{xi}(t), n_{xq}(t)\}$  and  $\{n_{yi}(t), n_{yq}(t)\}$  are the phase and quadrature components, respectively, having a normal distribution with a zero-mean and a variance of  $\sigma_n^2$ .

Given  $m(t) = 0$  and  $\frac{1}{2} P(e|0) + \frac{1}{2} P(e|1)$ , (8) are given by:

The baseband outputs  $V_x(t)$  and  $V_y(t)$  for the upper and the lower arms (Figure 2), respectively

are given as:

$$\begin{aligned} & \text{-----} \\ & \text{-----} \end{aligned}$$

$V_x(t)$  and  $V_y(t)$  have fixed mean values and the same variance given by:

With  $\sigma^2$ , the PDFs of  $V_x(t)$  and  $V_y(t)$  can be described by the Rice and the Rayleigh probability functions, respectively [19]:

$$\begin{aligned} & \text{-----} \\ & \text{-----} \end{aligned}$$

where  $I_0$  is the zero order modified Bessel function of the first kind [19].

The conditional BER for  $m(t) = 0$  can be derived as:

$$\text{-----}$$

By invoking changes of variables  $\rho = \frac{r}{\sigma}$  and  $\theta = \frac{\phi}{\sigma}$  and substituting into (16),

$P_{ec}$  now becomes:

$$\text{-----}$$

Defining the Q-function as [19]:

$P_{ec}$  is represented as:

$$P_{ec} = \frac{1}{2} \left[ 1 - \frac{1}{\sqrt{1 + \frac{2}{\text{SNR}}}} \right]$$

The electrical signal-to-noise ratio (SNR) at the output of the BPF is defined as:

$$\text{SNR} = \frac{P_s}{P_n}$$

$P_{ec}$  can be expressed in terms of the SNR by substituting (20) into (19):

$$P_{ec} = \frac{1}{2} \left[ 1 - \frac{1}{\sqrt{1 + \frac{2}{\text{SNR}}}} \right]$$

This result is same as the BER expression of FSK. With regards to the system sensitivity, PolSK and FSK techniques have complete equivalence [20].

Adopting the approach given in [21], the unconditional probability  $P_e$  is obtained by averaging (21) over the log normal (2) and the negative exponential irradiance fluctuation statistics (3) given as:

$$P_e = \int_0^\infty \frac{1}{2} \left[ 1 - \frac{1}{\sqrt{1 + \frac{2}{\text{SNR}}}} \right] \frac{1}{\Gamma} e^{-\frac{I}{\Gamma}} dI$$

$$P_e = \frac{1}{2} \left[ 1 - \frac{1}{\sqrt{1 + \frac{2}{\text{SNR}}}} \right]$$

## V. ANALYSIS OF THE POWER PENALTY DUE TO THE NON-IDEAL POLARIZATION BEAM SPLITTER

### A. An offset angle relative to one of the transmission axes of the linear polarized light

The PBS can be viewed as two ideal linear polarizers orthogonally oriented to each other. The non-ideal PBS results in an offset angle  $\theta$  from transmission axes of the linear polarized light as in Figure 4, where  $\theta_0$  and  $\theta_1$  are linearly polarized for the bit '0' and bit '1', respectively which contributes to the power penalty incurred. Figure 4 depicts the offset angle  $\theta$  from one transmission axis of the linear polarized light. In this case, bit '1' is detected without errors while bit '0' is not. The outputs from the PBS are given as:

Thus, the photo-currents generated by the PDs are:

$$I_0 = \frac{P_0}{2} \cos^2(\theta)$$

$$I_1 = \frac{P_0}{2} \sin^2(\theta)$$

The demodulated signal  $S_1$  at the output of the receiver is expressed as:

$$S_1 = I_0 - I_1$$

For  $m(t) = 0$ ,

$$I_0 = \frac{P_0}{2} \cos^2(\theta)$$

For  $m(t) = 1$ ,

$$I_1 = \frac{P_0}{2} \sin^2(\theta)$$

Since the offset angular error only reduces the signal power by a factor of  $\cos^2(\theta)$  when '0' is sent, the BER is given as:

$$BER = \frac{I_1}{I_0} = \frac{\sin^2(\theta)}{\cos^2(\theta)}$$

— —

**B. An offset angle relative to one of the transmission axes of the linear polarized light**

In Figure 5(a), the total offset angle of the transmission axes of both polarizers from the SOP of the incoming light is equivalent to  $\theta$ . The BER is calculated as:

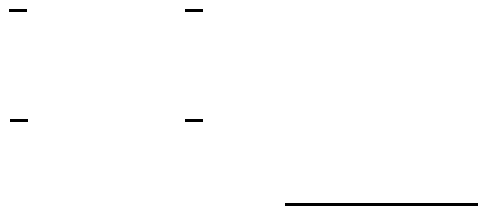

Since the offset angular error reduce the signal power by a factor of  $\cos^2 \theta$  for both ‘0’ and ‘1’, the conditional BER is expressed as:



In Figure 5(b), the total offset angle is the same as  $\theta$ . However, the orthogonality of the polarizers is preserved. The BER can be derived as:



Performances are the same for a non-orthogonal deviation of the transmission axes and for an

orthogonality-preserving deviation of the transmission axes. This is because of the equal amount of the offset angle for both cases.

Figure 6 illustrates the receiver sensitivity power penalty to achieve a BER of  $10^{-6}$  against different offset angles from one or both transmission axes of the incident light. The power penalty is higher for a deviation of the transmission axis of only one polarizer compared to an equal deviation of the transmission axes of both polarizers at the same offset angle. For example, when the offset angle is  $10^\circ$ , power penalties are  $\sim 0.16$  dB and  $\sim 0.06$  dB for Case A and Case B, respectively. When the offset angle increases to  $40^\circ$ , the difference in power penalty between the case A and case B rises to  $\sim 6.21$  dB. The power penalty required to achieve a BER of  $10^{-6}$  increases with the offset angle.

## VI. RESULTS AND DISCUSSIONS

### A. Performance degradation induced by LO phase noise $\Psi$

The phase noise  $\Psi$  generated from the LO causes a sensitivity penalty. As mentioned in the introduction section, coherent systems based on the envelop modulation (ASK) and angular modulation techniques (PSK) are highly sensitive to the phase noise effect. Phase noise is not considered in the proposed 2PolSK system because the transmitted information is encoded into polarization states and the electrical processing at the receiver is based on the square-law demodulation [22]. Figure 7 shows the numerical BER performance of the proposed 2PolSK system against the SNR for a range of phase noises without considering the turbulence. For comparison, performances of 2ASK and 2PSK systems are also shown. The expressions for BER for ASK and PSK in the presence of phase noise can be found in [23]. The phase noise  $\Psi$ , which is caused by the LO at the receiver, decreases the signal power by a factor of  $\cos^2(\Psi)$  for 2ASK and 2PSK modulation schemes [23]. For 2PSK, 2PolSK and 2ASK schemes to achieve a BER of  $10^{-9}$  in an ideal case ( $\Psi = 0^\circ$ ), SNR requirements are  $\sim 12.55$  dB,  $\sim 16.02$  dB and  $\sim 18.56$  dB, respectively. To achieve the same BER at  $\Psi = 30^\circ$ , SNRs increase to  $\sim 13.80$  dB,  $\sim 16.02$  dB and

~ 19.82 dB, respectively. For  $\Psi = 50^\circ$ , 2PolSK outperforms 2PSK and 2ASK by ~ 0.36 dB and ~ 6.39 dB, respectively.

### **B. Performance degradation induced by the turbulence**

Following the analytical approach outlined above, the BER performance of the coherent optical 2PolSK heterodyne transmission system through an FSO link is evaluated. The turbulence effects are considered as intensity noise. The simulation results are compared with 2ASK (with fixed threshold and adaptive threshold) and 2PSK. To investigate the effects of turbulence on the system performance, the BER metric and the fading penalty are shown under different channel conditions. Figure 8 depicts the fading penalty against the weak turbulence variances for a range of BERs. For a fixed BER, the fading penalty increases with the turbulence variance. To achieve a BER of  $10^{-3}$ , the fading penalties are ~ 3.3 dB and ~ 6.7 dB for  $\Psi = 50^\circ$  and  $\Psi = 70^\circ$ , respectively. Fading penalty is higher for lower values of BER at the same turbulence level. For example, for a turbulence variance of 0.5 the fading penalties are ~ 5.1 dB, ~ 8.8 dB and ~ 11.6 dB corresponding to BERs of  $10^{-3}$ ,  $10^{-6}$  and  $10^{-9}$ , respectively. A much higher fading penalty of ~ 17.2 dB at scintillation levels close to 0.9 is observed for a BER of  $10^{-9}$ , thus demonstrating the vulnerability of the system under extreme turbulence conditions.

BER performances of 2PolSK scheme under weak turbulence and strong turbulence regimes in comparison with 2ASK and 2PSK schemes are depicted in Figure 9. The superiority of 2PolSK modulation scheme in terms of the SNR required to achieve a desired BER is made evident. When the weak turbulence regime presents, 2PolSK outperforms and underperforms 2ASK and 2PSK, respectively in terms of SNR to achieve the same BER. When the turbulence variance is  $0.5$ , the SNR requirement is ~ 38.76 dB to achieve a BER of  $10^{-6}$  for 2PolSK scheme. The value of SNR rises to ~ 46.26 dB at the same turbulence condition when the error performance level is raised to a BER of  $10^{-8}$ . The SNR is higher for other modulation techniques as shown in the figure.

The performance of the proposed 2PolSK system in a strong turbulence FSO channel is also shown. The BER performances in the strong turbulence regime are much worse than they are in the weak turbulence regime for the same SNR. For a SNR of 48 dB, BERs of 2PolSK are equal to  $\sim 10^{-9}$  and  $\sim 10^{-8}$  for  $\alpha = 0.1$  and  $\alpha = 0.2$ , respectively. The BER performance of 2PolSK is placed between 2ASK (with fixed threshold and adaptive threshold detection schemes) and 2PSK. At SNR = 34 dB and  $\alpha = 0.1$ , the BER performances are  $\sim 10^{-9}$ ,  $\sim 0.01$ ,  $\sim 0.02$  and  $\sim 0.19$  for 2PSK, 2PolSK, 2ASK with adaptive threshold and fixed threshold schemes, respectively. Information encoded in phase and SOPs outperform amplitude modulation in the strong turbulence induced fading channel.

The difference in the performance of different modulations is attributable to how the information is embedded in the optical carrier signal. Compared to the intensity modulation / direct detection schemes, the PolSK scheme can improve the receiver sensitivity. 2ASK is more prone to the intensity fluctuations compare to 2PolSK and 2PSK where information is embedded in the SOP and phase, respectively.

## VII. CONCLUSION

The analytical conditional and unconditional error probabilities for a coherent optical 2PolSK heterodyne system adopted for an FSO communication link through the weak and strong atmospheric turbulence channels were calculated and verified using computer simulations. Results presented have shown the susceptibility of 2PolSK scheme when it is operated in a turbulence environment in terms of the required SNR in order to achieve a given BER. A fading penalty of  $\sim 8.1$  dB was observed at a turbulence variance of  $0.1$  at a BER of  $10^{-9}$ ; increasing to  $\sim 17.2$  dB at a turbulence variance of  $0.2$ . The receiver sensitivity penalty due to the non ideal PBS has also been analyzed. The comparative study of 2PolSK, 2ASK and 2PSK has shown that 2PolSK offers the highest immunity to the LO phase noise while offers improved performance in a turbulence channel. Therefore, the choice of modulation scheme depends on



the application and requires a trade-off between the simplicity, power and bandwidth efficiencies.

## REFERENCES

- 1 Iniguez, R.R., Idrus, S.M., and Sun, Z.: 'Introduction': 'Optical Wireless Communications - IR for Wireless Connectivity' (Taylor & Francis Group, LLC, 2008), pp. 1 - 24
- 2 Ciaramella, E., Arimoto, Y., Contestabile, G., Presi, M., D'Errico, A., Guarino, V., and Matsumoto, M.: '1.28 terabit/s (32x40 Gbit/s) WDM transmission system for free space optical communications', IEEE Journal on Selected Areas in Communications December 2009, 27 (9), pp. 1639 - 1645
- 3 Popoola, W.O., and Ghassemlooy, Z.: 'BPSK subcarrier intensity modulated free-space optical communications in atmospheric turbulence', Journal of Lightwave Technology, 15 April 2009, 27, (8), pp. 967 - 973
- 4 Iniguez, R.R., Idrus, S.M., and Sun, Z.: 'Atmospheric transmission limitations': 'Optical Wireless Communications - IR for Wireless Connectivity' (Taylor & Francis Group, LLC, 2008), pp. 25 - 42
- 5 Zhao, X., Yao, Y., Sun, Y., and Liu, C.: 'Circle polarization shift keying with direct detection for free-space optical communication', Optical Communications and Networking September 2009, 1, (4), pp. 307-312
- 6 Pratt, W.K.: 'Atmospheric propagation', in Ballard, S.S. (Ed.): 'Laser communication systems' (John Wiley & Sons, Inc., 1969), pp. 128 - 144
- 7 Saleh, A.A.M.: 'An investigation of laser wave depolarization due to atmospheric transmission', IEEE Journal of Quantum Electronics, June 1967, 3, (6), pp. 256
- 8 Betti, S., Marchis, G.D., and Iannone, E.: 'Coherent systems: structure and ideal performance', in Chang, K. (Ed.): 'Coherent optical communications systems' (John Wiley & Sons, Inc, 1995), pp. 242 - 313
- 9 Chi, N., Yu, S., Xu, L., and Jeppesen, P.: 'Generation and transmission performance of 40 Gbit/s polarisation shift keying signal', Electronics Letters, 28 April 2005, 41, (9), pp. 547 - 549
- 10 Grosinger, J.: 'Investigation of polarization modulation in optical free space communications through the atmosphere'. master, Technical University of Vienna, February 2008
- 11 Karbassian, M.M., and Ghafouri-Shiraz, H.: 'Transceiver architecture for incoherent optical CDMA network based on polarization modulation', Journal of Lightwave Technology, 15 December 2008, 26, (24), pp. 3820-3828
- 12 Zhu, X., and Kahn, J.M.: 'Free-space optical communication through atmospheric turbulence channels', IEEE Transactions on Communications, August 2002, 50, (8), pp. 1293-1300
- 13 Wilson, S.G., Brandt-Pearce, M., Cao, Q., and Leveque, J.H.: 'Free-space optical MIMO transmission with Q-ary PPM', IEEE Transactions on Communications, August 2005, 53, (8), pp. 1402 - 1412
- 14 Osche, G.R.: 'Optical detection theory for laser applications' (Wiley, New Jersey, 2002. 2002)
- 15 Andrews, L.C., and Phillips, R.L.: 'I-K distribution as a universal propagation model of laser beams in atmospheric turbulence', Journal of Optical Society of America, 1985, 2, (2), pp. 160-163
- 16 Al-Habash, M.A., Andrews, L.C., and Phillips, R.L.: 'Mathematical model for the irradiance probability density function of a laser beam propagating through media ',

- August 2001, 40, (8), pp. 1554-1562
- 17 Benedetto, S., Djupsjobacka, A., Lagerstrom, B., Paoletti, R., Poggiolini, P., and Mijic, G.: 'Multilevel polarization modulation using a specifically designed LiNbO<sub>3</sub> device', IEEE Photonics Technology Letters, August 1994, 6, (8), pp. 949-951
  - 18 Collett, E.: 'The Stokes polarization parameters': 'Polarized light: fundamentals and applications' (Marcel Dekker, Inc., 1993), pp. 33-66
  - 19 Proakis, J.G.: 'Digital communications' (McGraw-Hill, Inc., 1995. 1995)
  - 20 Calvani, R., Caponi, R., Delpiano, F., and Marone, G.: 'An experiment of optical heterodyne transmission with polarization modulation at 140 Mbit/s bitrate and 1550 nm wavelength ', GLOBECOM '91, 2-5 December 1991 3, pp. 1587-1591
  - 21 Jurado-Navas, A., Garcia-Zambrana, A., and Puerta-Notario, A.: 'Efficient lognormal channel model for turbulent FSO communications', Electronics Letters, February 1, 2007, 43, (3), pp. 178-179
  - 22 Betti, S., Marchis, G.D., and Iannone, E.: 'Performance degradation sources in coherent optical systems', in Chang, K. (Ed.): 'Coherent optical communications systems' (John Wiley & Sons, Inc., 1995), pp. 314 - 379
  - 23 Stremler, F.G.: 'Introduction to communication systems' (Addison-Wesley Publishing Company, 1982. 1982)

## List of Figures

Figure 1: (a) PolSK transmitter block diagram, and (b) LiNbO<sub>3</sub> modulator. LD, laser diode; PBS: polarizing beam splitter.

Figure 2: A block diagram of the coherent optical PolSK heterodyne receiver. LO: local oscillator; DC: directional coupler; BPF: bandpass filter; LPF: lowpass filter.

Figure 3: SOPs at the output of PolSK receiver.

Figure 4: An offset angle  $\theta$  relative to  $\theta_0$  polarized light.

Figure 5: (a) A non-orthogonal deviation of the transmission axes, and (b) an orthogonality-preserving deviation of the transmission axes from the SOPs of the incoming light.

Figure 6: Receiver sensitivity power penalty against the offset angle  $\theta$  at a BER of  $10^{-6}$  for: Case A: an offset angle relative to one of the transmission axes of the linear polarized light; and Case B: an offset angle relative to both transmission axes of the linear polarized light.

Figure 7: The comparison of the BER performance of 2ASK, 2PSK and 2PolSK against the normalized electrical SNR for a range of phase noises with no atmospheric turbulence.

Figure 8: The fading penalty against the log intensity for the PolSK heterodyne system in a weak atmospheric turbulence under different BER conditions.

Figure 9: The BER against the SNR for 2PolSK compared to the 2ASK and 2PSK in weak and strong  $\alpha$  turbulence regimes.

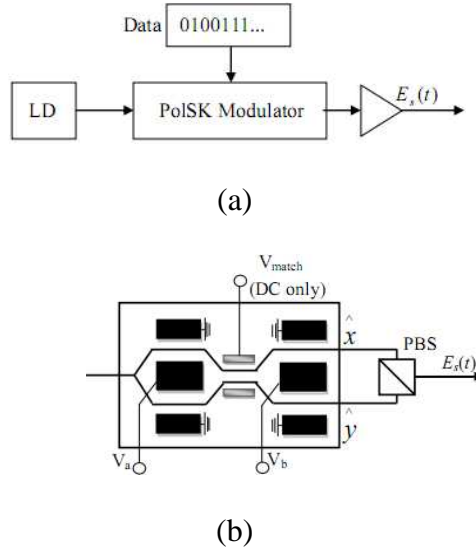

Figure 1: (a) PolSK transmitter block diagram, and (b) the LiNbO<sub>3</sub> modulator. LD, laser diode; PBS: polarizing beam splitter.

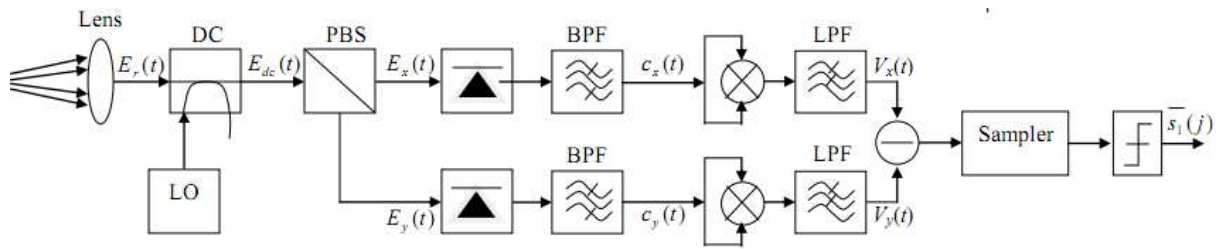

Figure 2: The block diagram of the coherent optical PolSK heterodyne receiver. LO: local oscillator; DC: directional coupler; BPF: bandpass filter; LPF: lowpass filter.

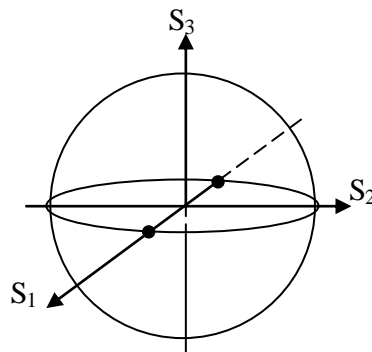

Figure 3: SOPs at the output of the PolSK receiver.

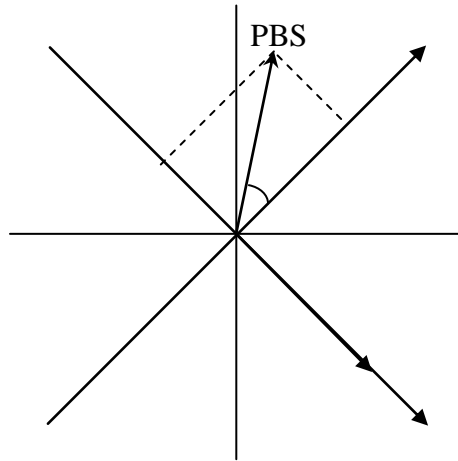

Figure 4: An offset angle relative to polarized light.

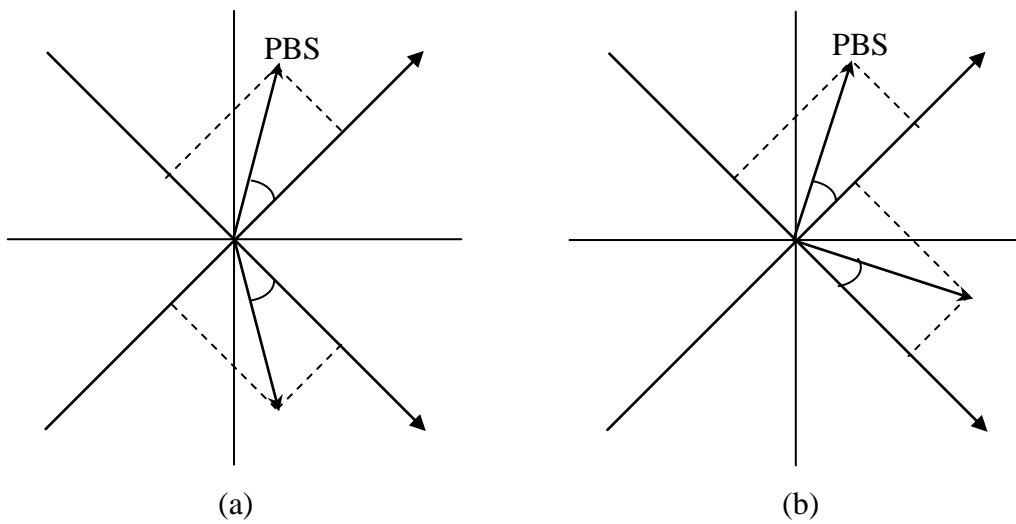

Figure 5: (a) A non-orthogonal deviation of the transmission axes, and (b) An orthogonality-preserving deviation of the transmission axes from the SOPs of the incoming light.

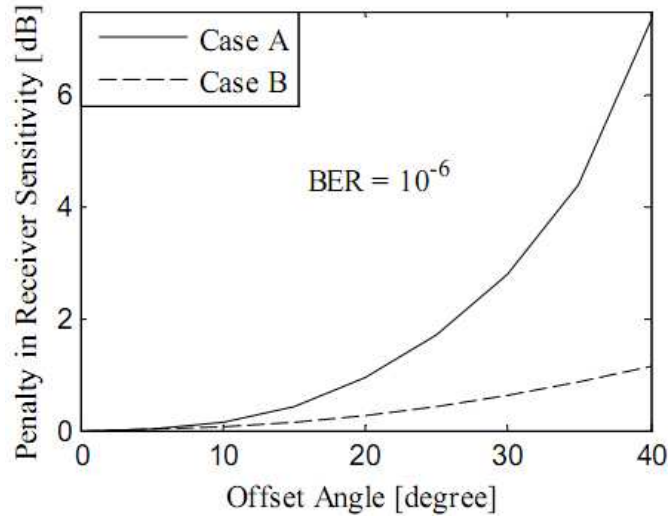

Figure 6: Receiver sensitivity power penalty against the offset angle at a BER of  $10^{-6}$  for: Case A: an offset angle relative to one of the transmission axes of the linear polarized light; and Case B: an offset angle relative to both transmission axes of the linear polarized light.

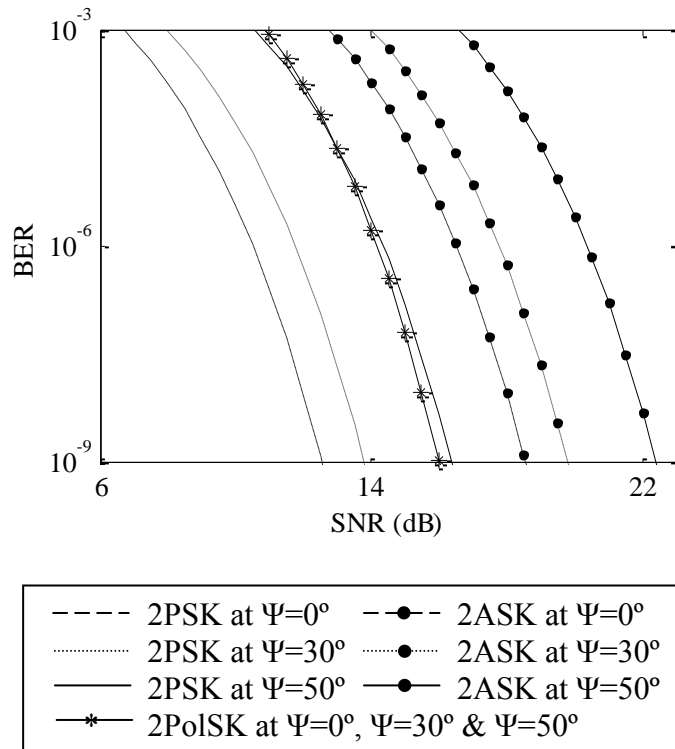

Figure 7: The comparison of the BER performance of 2ASK, 2PSK and 2PolSK against the normalized electrical SNR for a range of phase noises with no atmospheric turbulence.

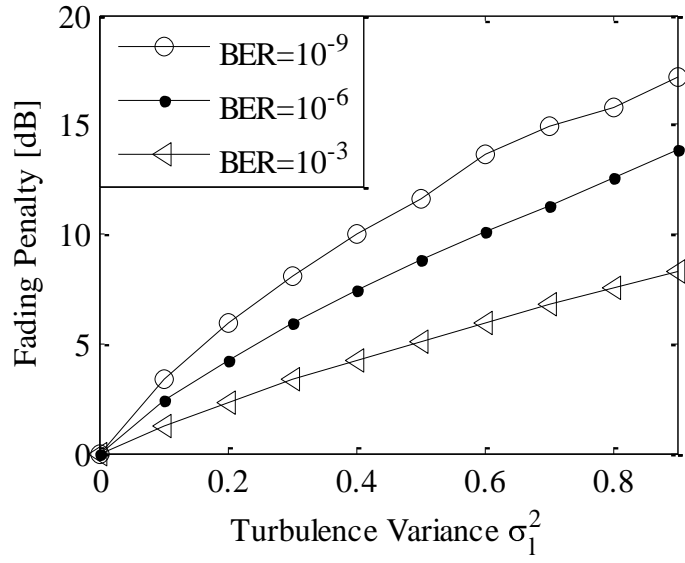
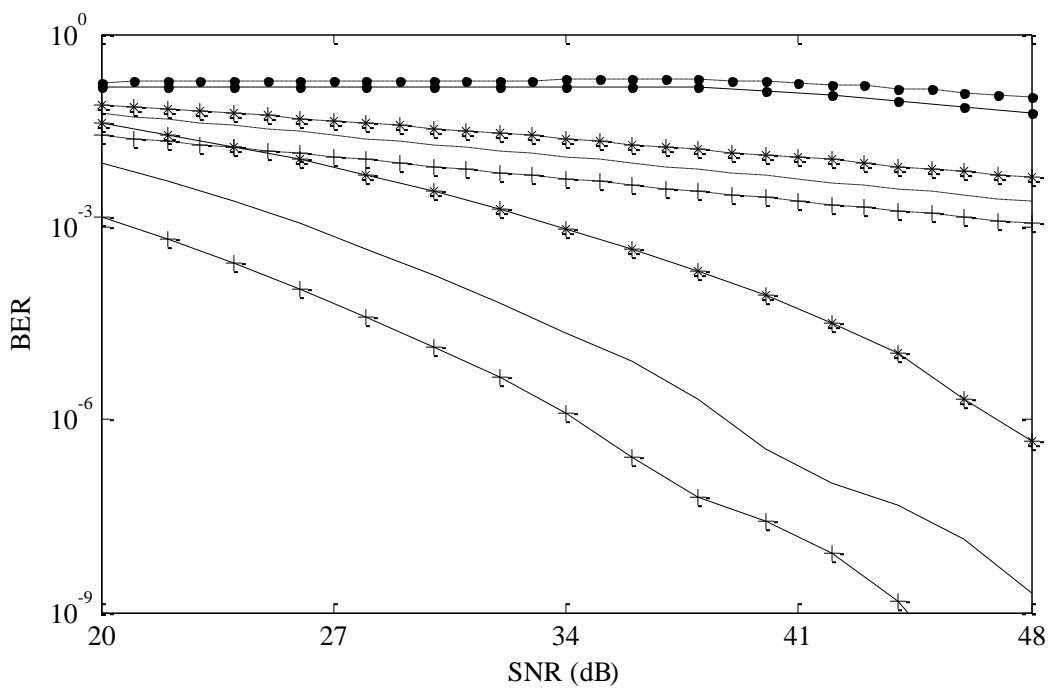

Figure 8: The fading penalty against the log intensity for the PolSK heterodyne system in a weak atmospheric turbulence under different BER conditions.



	2ASK with fixed threshold	2ASK with adaptive threshold	2PSK	2PolSK
	—●—	—*—	—+—	——
	- -●- -	- -* - -	- -+ - -	- - - -

Figure 9: The BER against the SNR of 2PolSK compared to the 2ASK and 2PSK in weak and strong turbulence regimes.